

3M

Wired Intercom System

Performance Series

Models 2470 and 2475

Installation Instructions

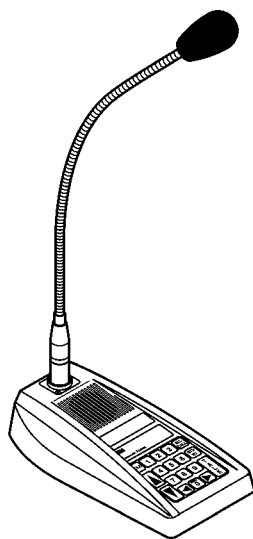

Station Selector

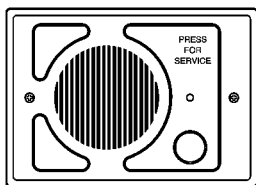

Call Station

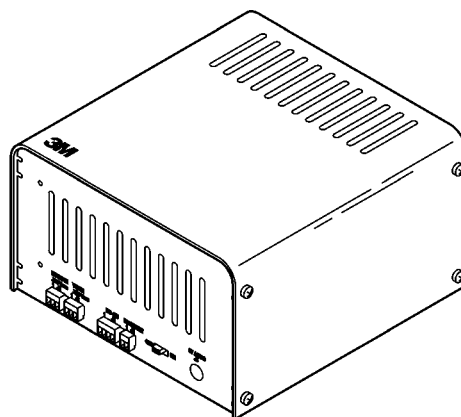

Communications Controller

FCC Information

This device complies with part 15 of the FCC rules. Operation is subject to the following conditions:

- This device must not cause harmful interference.
- This device must accept any interference received including interference that may cause undesired operation.

Changes or modifications not expressly approved by the party responsible for compliance could void the user's authority to operate the equipment.

© 3M (IPC) 2002. All rights reserved.

Call (800) 328-0033

Revision Record

Date	Revision	Reason For Change
2/02/02	01	Preliminary manual released
4/08/02	02	Preliminary second draft
4/11/02	03	Preliminary third draft
4/15/02	A	Manual Released
4/19/04	B	Revisions made

Table of Contents

System Components 1

I/O Card and Noise Reduction Module Installation 2

I/O Card Installation 2

3M™ Model A125, Noise Reduction Module, Installation (Optional)..... 3

Component Placement..... 4

Communications Controller..... 4

Power Supply..... 4

Call Stations..... 5

Station Selectors 5

Wiring the System 6

Configuration Worksheets 7

Wiring Call Stations 7

Wiring Station Selectors..... 7

Wiring Communications Controller 8

Initializing the System 9

System Mode Selection: 9

Initialization instructions for Pump Mode (factory default)..... 10

Initialization Instructions for Island Mode 10

Programming the System 11

Programming State 11

Error Message..... 12

Parameter Selection 12

Keypad Function Definitions (for Text entry) (Programming State) 15

Adjusting the System 17

Inbound Audio Volume Level 17

VOX (Voice Operated Transmission) Sensitivity Level 17

Outbound Talk Volume Level 17

Outbound Music/Messaging Volume Level (Only for systems that use
Music/Messaging) 18

Testing the Functions..... 18

Configuration Worksheets 19

System Components

The Performance Series Intercom System consists of:

- A minimum of one Model 2475 Station Selector
- One Model 2470 Communications Controller
- A maximum of 24 Call Stations

The system provides two-way audio communication between the Station Selector and the 24 call stations. The system also provides communications between station selectors. It is a single channel, half-duplex, wired system. Figure 1 shows the components.

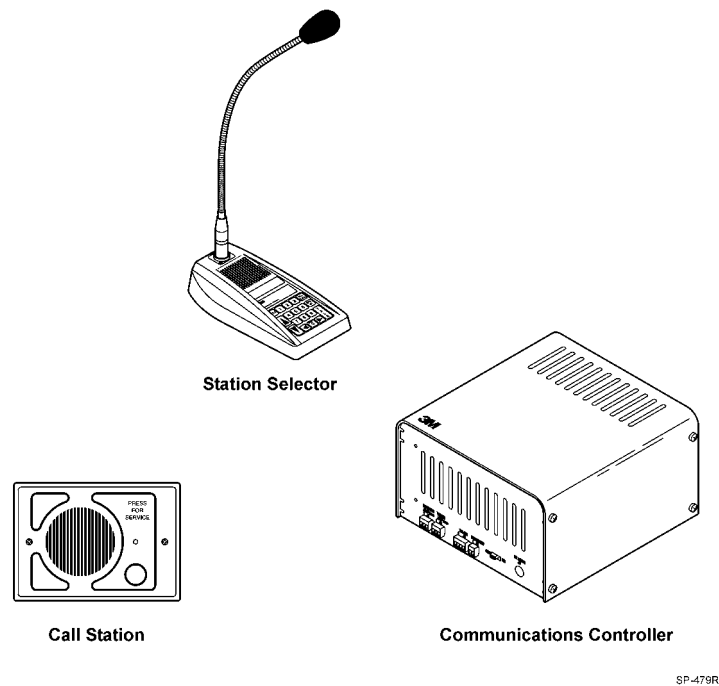

Figure 1. D-2400 Intercom System Components

Material Required (Not Supplied)

- Assortment of screws, anchors, and cable clamps.
- Sufficient twisted pair sets of audio cable to connect other components such as Station Selector, Call Stations, etc. See Figure 1.

Important

The wires for the speaker connection must be twisted pairs and shielded for proper operation.

I/O Card and Noise Reduction Module Installation

I/O Card Installation

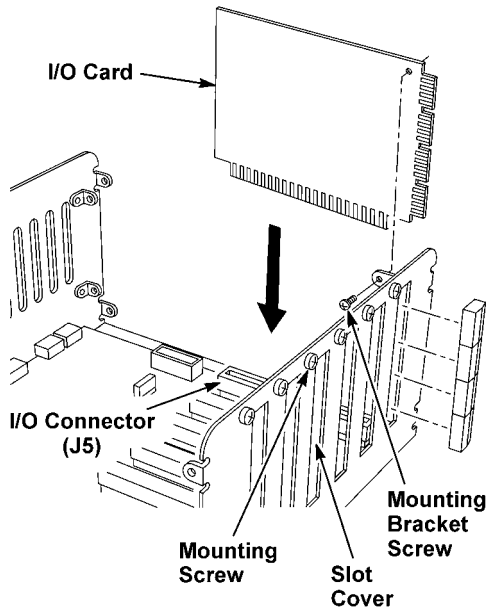

SP-476R

Figure 2. I/O Card Installation

Be sure the system is powered off!

1. Remove 4 screws on each side of the Communications Controller cover.
2. Remove cover.
Note: Insert I/O cards beginning from connector J5. Add additional I/O cards sequentially (J6, J7, etc.).
3. Remove slot cover and mounting screw. Refer to Figure 2.
4. Remove all terminal blocks from edge of I/O card.
5. Insert I/O card into I/O connector by pressing gently into place.
6. Use slot cover mounting screw to secure I/O card to chassis.
7. Insert terminal blocks into I/O card station ports.
8. Repeat until all I/O cards are installed.
9. Replace cover and 8 screws.

! Important

A larger power supply must be used if more than four (4) I/O cards are installed. Use D2470-20 power supply Part Number 78-8117-4153-3 when more than four (4) I/O cards are installed.

After the larger power supply is installed, Remove the following Warning label:

WARNING
Do not add any I/O cards to these slots unless power supply output rating exceeds 4 Amps. See installation instructions for details.

✓ Note

If adding additional I/O cards after initial installation, you must re-program parameter 03, “max stations.”

3M™ Model A125, Noise Reduction Module, Installation (Optional)

Figure 3. Noise Reduction Module Installation

Be sure the system is powered off!. Refer to Figure 3.

The optional 3M™ A125 Noise Reduction board (3M part number 78-9236-6453-2) improves the inbound intelligibility of an intercom system by reducing environmental background noise from vehicles, airplanes, noisy intersections, wind, etc.

1. On the A125 circuit board, set the jumpers and switches as follows:
 - Set JMP1 and JMP2 to position A.
 - Set SW1 number 1 ON
 - Set SW1 number 2 ON
 - Set SW1 number 3 as desired:
 - With SW1 number 3 OFF, the A125 is set for restaurant noise reduction.
 - With SW1 number 3 ON, the A125 is set for truck stop noise, which provides more noise reduction with slightly more voice degradation.
 - Set SW1 number 4 as desired:
 - With SW2 number 4 ON, the higher-end frequencies are increased by 3 dB. This should be set to the customer's preference.
 - SW1 numbers 5 and 6 are not used.
2. Remove 4 screws on each side of Communications Controller cover.
3. Remove cover.
4. Plug Noise Reduction Module ribbon cable into Connector J12.
5. Use upper and lower mounting brackets to secure Noise Reduction Module to Communications Controller chassis as shown in Figure 3.
6. On the Model 2470 circuit board, Set JMP1 to open. LED1 (adjacent to JMP1) blinks when noise reduction module is active.
7. Replace cover and 8 screws.

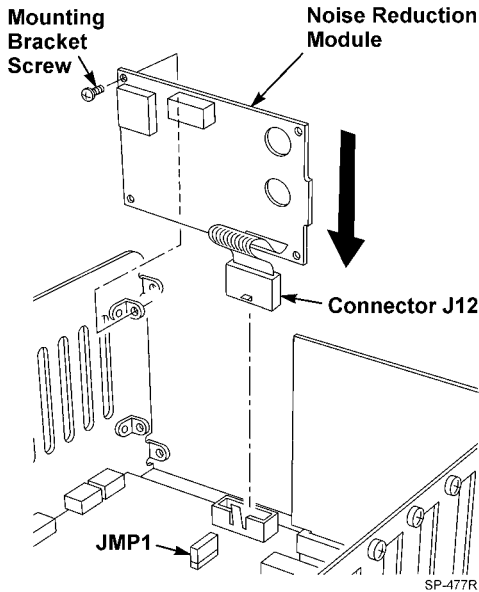
Component Placement

This section describes placement of the Performance Series Intercom System components:

Communications Controller

For proper system operation, locate the Communications Controller:

1. Near the conduit termination of the Call Station wiring.
2. Near the power source.
3. At least 10 feet away from electrical noise sources such as the following:
 - large electrical motors (such as air conditioners, freezers, and coolers)
 - any electrical components that arc (i.e., relays)
 - ballasts (for light fixtures)
4. In a secure room away from traffic.
5. Approximately 5 feet above the floor.
6. Where it is accessible from the top, bottom, and both sides.
7. In a dry and heated (between 50° and 100° Fahrenheit) location.

See Figure 4.

Power Supply

Locate the power supply as follows:

1. Install the power supply mounting bracket in a preferred location, as shown in Figure 4.
2. Insert the power supply transformer into the mounting bracket, as shown in Figure 4.

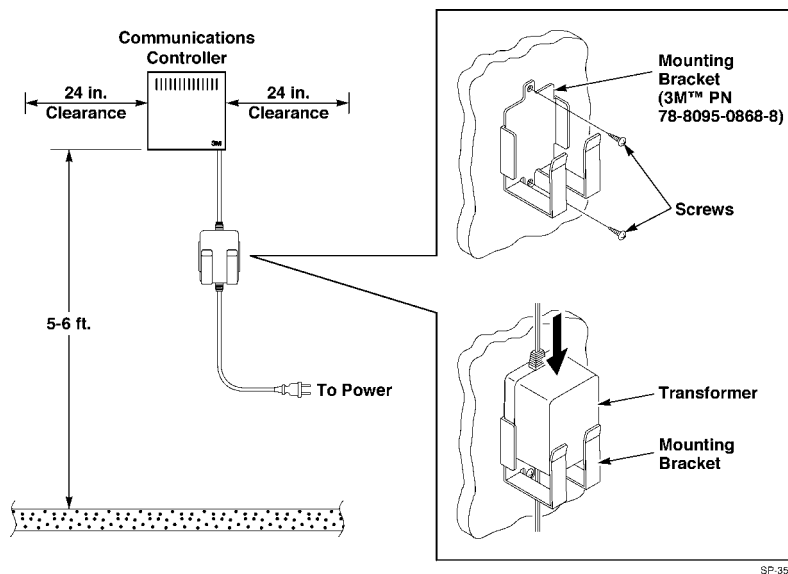

Figure 4. Suggested Communications Controller Placement

Call Stations

For proper system operation, install the Call Stations in locations:

1. Chosen for ease of use.
2. At least 48 inches above the pavement.

✓ **Note**

Local codes may dictate placement of call stations.

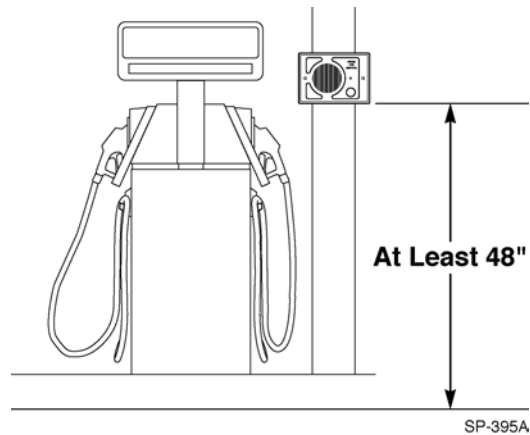

Figure 5. Suggested Call Station Placement

Station Selectors

For proper system operation, locate the Station Selectors:

1. At locations chosen for maximum efficiency.
2. On counters, mounted on pedestals, or mounted on walls.
3. In dry and heated areas.

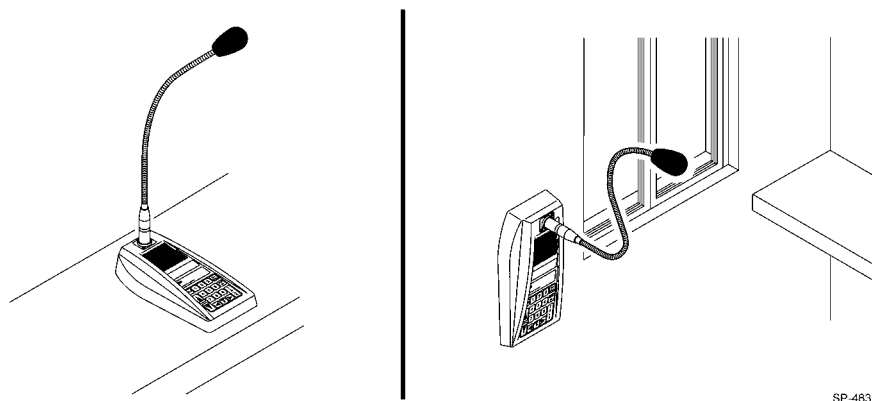

Figure 6. Suggested Station Selector Station Placement

Wiring the System

Depending on distance, use twisted pair, 14-22 AWG audio cables when wiring the Wired Intercom System, components. Figure 7 shows an overview of the cable types and number of conductors required for each unit. Table 1 shows wire gauge required for different distances between components. We recommend installing a separate power supply transformer (3M part number 78-8095-0910-8), for each Station Selector located over 100 feet from the Communications Controller,

Note:

The RS 485 cable carries DC power for the Station Selectors, requiring a larger gauge wire.

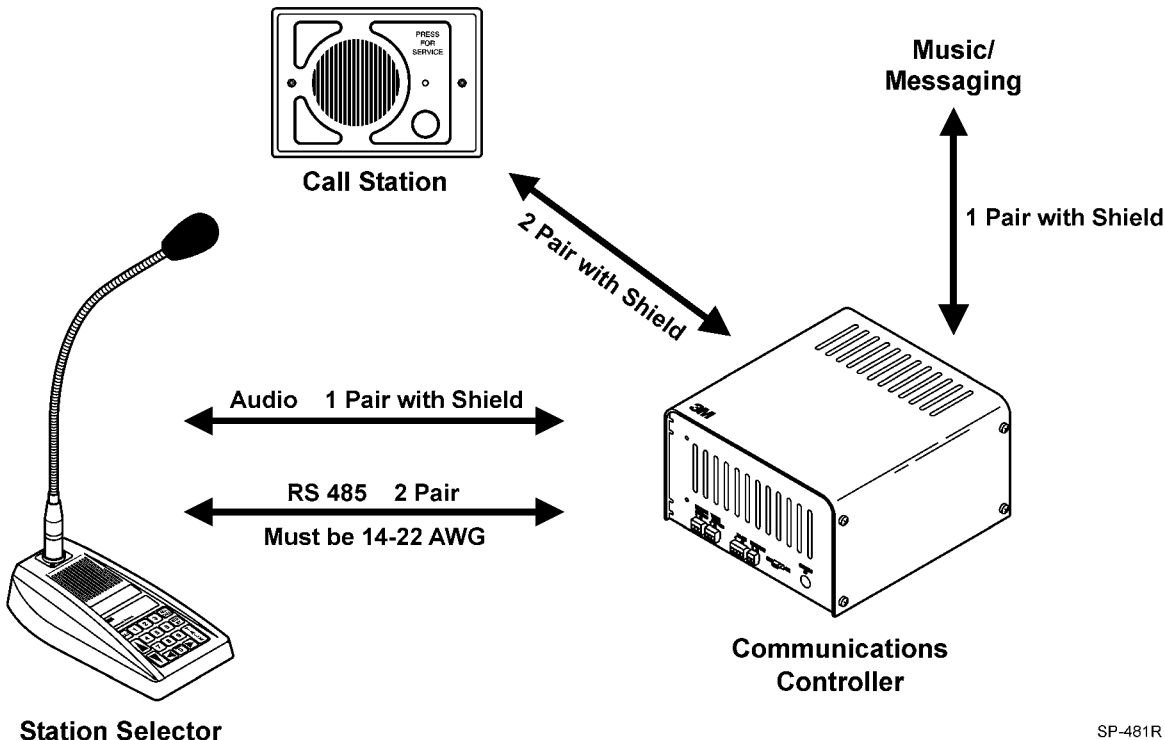

SP-481R

Figure 7. Cable and Connection Requirements

All Audio Wiring	
Wire Gauge	Distance Between Components
22	Up to-309 feet
20	310-493 feet
18	494-783 feet
16	784-1245 feet
14	1246-1980 feet

RS 485 Cable (only)	
Wire Gauge	Distance Between Components
22	Up to 62 feet
20	63-99 feet
18	100-157 feet
16	158-249 feet
14	250-396 feet

Table 1. Wire Size Requirements

Configuration Worksheets

Use Configuration Worksheets 1 through 3 (located at the end of this document) to plan and record your system configuration. You can record the system wire locations, wire color scheme, and program settings on the worksheets. Store the worksheets inside the cover of the Communications Controller.

Wiring Call Stations

Call Station wiring consists of the following for a one-button, four-wire system:

- 2 Speaker wires.
- Speaker shield wire (used as Common for buttons).
- Call switch.
- LED wire. (if Call Station contains LED)

Configuration Worksheet 1 shows how to connect the Call Stations to the proper Communications Controller ports.

Wiring Station Selectors

⚠ Important

The D-2400 System is powered by one power supply that provides power for the Communications Controller and a maximum of three Station Selectors. A separate power supply (3M part number 78-8095-0910-8) must be plugged into each Station Selector that exceeds the three Station Selector limit. We recommend installing a separate power supply if the cable length from the Station Selector to the Communications Controller exceeds 100 feet.

Wiring Station Selectors involves connecting a minimum of 7 wires: 3 audio wires and 4 power and communications wires.

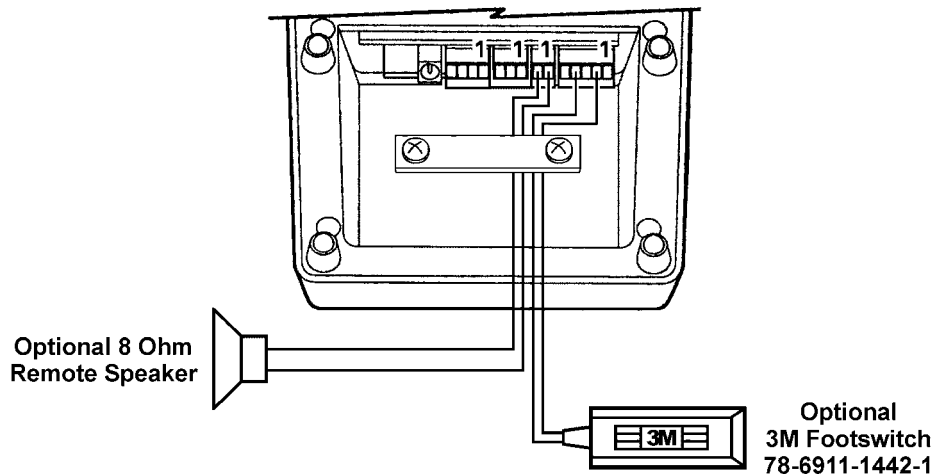

SP-542

Figure 8. Connecting Optional Accessories to Station Selector

Refer to Configuration Worksheets 2 and 3 to determine the specific wires and connections to be made.

Wiring Communications Controller

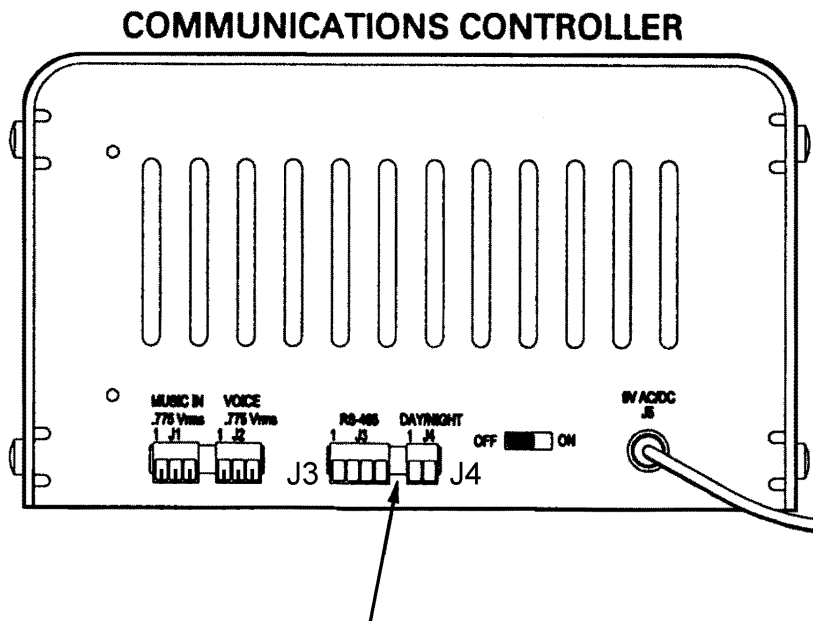

Take care not to insert Plug P3 into the open space between J3 and J4

SP-541

Figure 9. Connecting P3 to Communications Controller

Refer to Configuration Worksheets 2 and 3 to determine the specific wires and connections to be made.

Initializing the System

System Mode Selection:

Before starting the system Initialization process, you must determine the mode of operation. Check the number of speakers at each Multiple Product Dispenser (MPD). Typically, each active side of the MPD is identified as a separate pump:

Number of Speakers at MPD	Mode of Operation to Use
1	Island Mode
2	Pump Mode

Table 2. Determining Mode of Operation

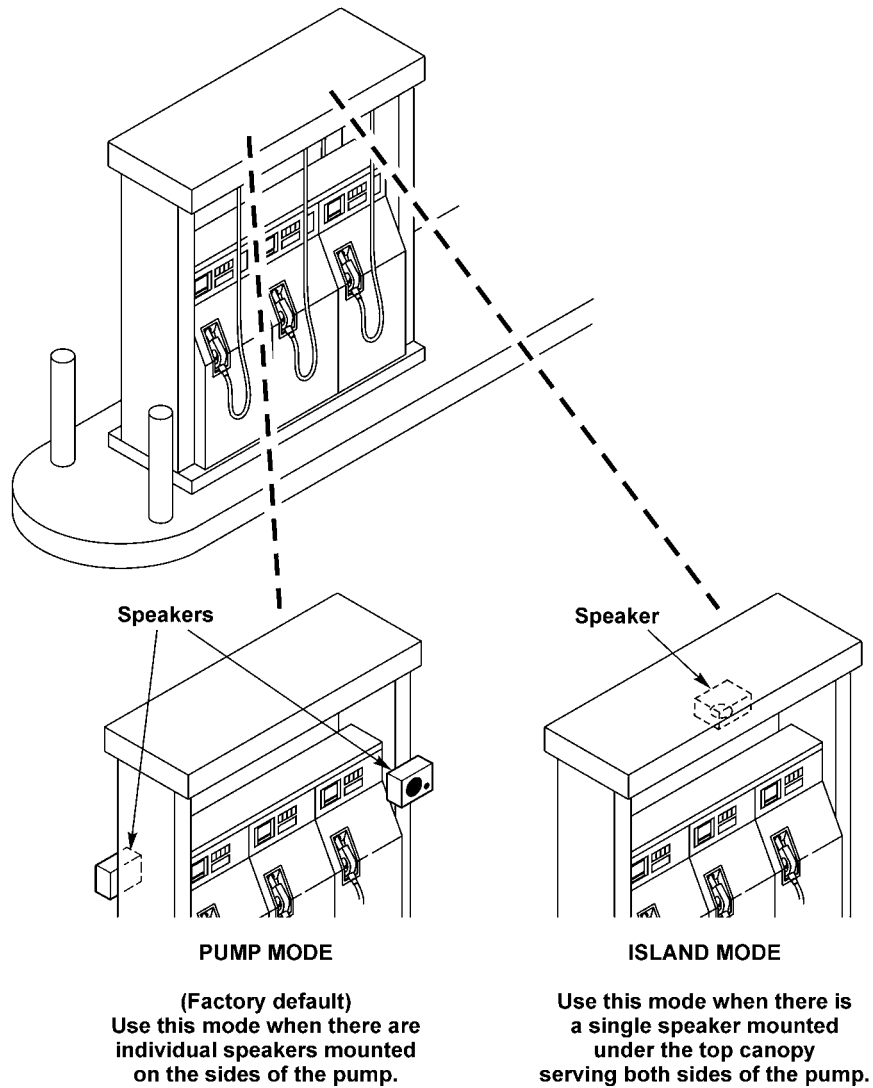

Figure 10. Pump Mode and Island Mode

⚠ Important

1. Initialization will erase all memorized parameters and restore factory default values.
2. If Pump Mode (factory default) is desired, initialization is not required.
3. If software is upgraded, the system **must** be re-initialized.

Initialization instructions for Pump Mode (factory default)

```
Init PUMP Mode
'TALK' = Yes
1:PUMP MODE
```

Pump mode assigns each Call Station to a single number (1 through 24). Pump mode is used when there are 2 speakers per M.P.D., and each speaker serves one side of the dispenser.

Procedure 1: Press and hold the ALL CALL key while applying power to the Selector.

OR

Procedure 2: Reset or remove power from the Station Selector using one of the following methods:

- a. Unplug the RS485 cable.
- b. Press and hold the STD BY key while entering the numeric code 911.

Initialization Instructions for Island Mode

```
Init ISLAND Mode
'TALK' = Yes
```

Island mode assigns each Call Station to two consecutive numbers (1&2,, 3&4,). Island mode is used where a single speaker serves both sides of a dispenser.

Procedure 1: Press and hold the HOLD key while applying power to any Selector.

OR

Procedure 2: Reset or remove power from any Station in one of the following ways.

- a. Unplug the RS485 cable.
- b. Press and hold the STD BY key while entering the numeric code 911.

Resetting the Station Selector (Reset)

To reset only the station selector:
 1. Press and hold the STD BY key.
 2. Enter the numeric code: 911.

Resetting the System (Reset)

To reset only the entire system:
 1. Press and hold the STD BY key.
 2. Enter the numeric code: 8642.

DEFINITIONS:

1) **Power On Reset:**

Turning off power, and then turning it back on. Commonly referred to as a “Cold Boot”.

2) **Reset:**

Restarting the micro controller firmware. Commonly referred to as the “Warm Boot.”

2) **Re-Initialize:**

Over writes the EEPROM memory with factory default values. This process also selects “Pump” or “Island” mode of operation

3) **Programming Mode:**

change the EEPROM memory from factory default values to user preferences

Programming the System

⚠ Important

If you have not selected the mode of operation (Pump or Island) do so now! See **System Mode Selection**.

Programming State

To program the Performance Series Intercom System, it is necessary to put the system in the programming state. From this state, the entire system is configured and all memorized parameters are adjusted.

To enter the programming state, simultaneously:

Press and hold the STD BY key.

Enter the numeric code: 97531.

The display shows:

```
01:Selector ID #
      {01}
```

The Parameter #, Parameter Name/Value, and Parameter Value fields are as shown below.

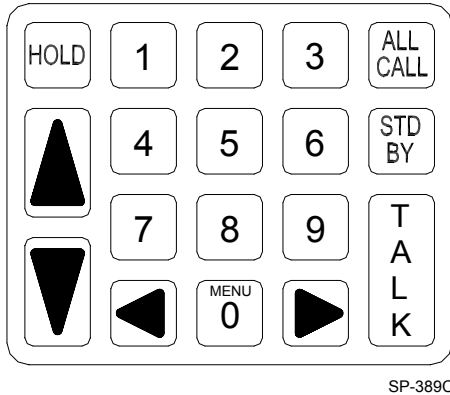
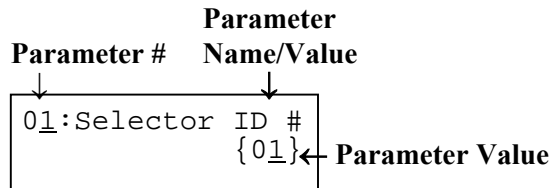

Figure 11. D-2400 Keypad



The “_” indicates cursor position. To move the cursor from one field to another, use the Left Arrow and Right Arrow keys.

To input data at the cursor position, do one of the following:

- Use the Up Arrow and Down Arrow keys to scroll to desired value.
- Use the 1, 2, 3, 4, 5, 6, 7, 8, 9, 0/Menu keys.

The STD BY key clears a field to a default value (space for text or the default value).

The HOLD key shifts case for text data.

The ALL CALL key exits from the programming state and enters the Off Line mode.

⚠ Important

All Station Selectors ship from the factory with a default ID number of 15. It is important to connect and power up each new Station Selector, **ONE STATION SELECTOR AT A TIME**, when installing a new system. Doing this allows you to change the ID number to a lower value (start at 1) and avoid the erratic behavior caused by multiple Station Selectors sharing the same ID number.

Error Message

```
! E R R O R !
NO COMMUNICATION
```

The system will display one error message: No Communication.

This message occurs when there is no communications between the Station Selector and Communications Controller. To correct this:

- Be sure Communications Controller is powered on.
- Be sure pins 2 and 3 of J3 on the Communications Controller are connected to pins 2 and 3 of J8 (RS-485 connector) on the Station Selector. Polarity must be correct!
- Call 3M Technical Service to confirm software compatibility between station selector and communication controller.

Parameter Selection

Memorized parameters are given below. These parameters are stored in the EEPROM. The 16-character by 2-row LCD displays the parameters.

```
01:Selector ID #
      {01}
```

A number (1 to 15 inclusive). Default = 15. This number must be unique relative to all other Station Selector ID numbers used in the system.

```
02:Controller
      {D2400 1-Chnl}
```

Displays the model of the Communications Controller connected to the Station Selector. If no Communications Controller is connected {Undefined} will be displayed.

```
03:Max Stations
      {24}
```

A number (1 to 24 inclusive). Total number of Call Stations in the system. Default = What the Communications Controller senses. Stations are numbered starting with 1 up to this value. This value should be adjusted to equal the number of speakers connected to the Communications Controller, preventing an operator from accessing an unwired Call Station. If installing or removing additional I/O cards after the initial installation, you must re-program parameter03for each station selector connected to the system.

```
04:Silence Calls
      {Off}
```

A value (On, Off). Default = Off.
Off = normal operation.
On = Station Selector will only respond to page requests from other Station Selectors. It will not respond to Call Station requests. This is useful for a Station Selector placed in a manager's office. The manager will not hear Call Station alerts. He will hear only page requests from employee's Station Selectors.

```
05:Alert Volume
      {08}
```

A number (1 to 15 inclusive). Default = 08. Adjusts the volume of the Station Selector alert tone (Chime or Beep). A value of 15 is the loudest setting.

```
06:Alert Type
      {Chime}
```

Beep or Chime. Default = Chime.

<pre>07:VOX Enable {Off}</pre>	<p>A value (On, Off). Default = Off. Enables the VOX (Voice Operated Transmission) feature.</p>
<pre>08:VOX Sensitive {15}</pre>	<p>A number (1 to 15 inclusive). Default = 15 (most sensitive). Adjust this value to accommodate the ambient noise level at the Station Selector location. Use a lower value for a higher noise environment.</p>
<pre>09:Talk Vol{10} S=01 PUMP # 01</pre>	<p>A number (1 to 15 inclusive). Default = 08. The outbound voice volume is adjusted for all Call Stations simultaneously. Each Call Station can be individually selected. An assistant can be sent out to each Call Station. When the Talk key is momentarily pressed, it remains in the Talk state until pressed again, and then it remains in the Listen state. This allows the installer to communicate with the assistant over the intercom in setting the proper volume level.</p>
<pre>10:Music Volume {08}</pre>	<p><i>This value must be adjusted after adjusting Talk volume!</i> A number (0 to 15 inclusive). Default = 08. With a value of {00} music will be muted.</p>
<pre>11:Priority{Off} S=xy: User Name</pre>	<p>A value (Off, 1 to 24 inclusive). Default = Off. The Call Station selected here has top propriety call in over all other Call Station requests.</p>
<pre>12:Auto Standby {On}</pre>	<p>A value (On or Off). Default = On. Enables the 90-second station connection time out. If the Talk key is not pressed within 90 seconds, the Station Selector returns to the Standby mode.</p>
<pre>13:Standby Mode {Silence}</pre>	<p>A value (Silence or All Listen). Default = Silence. “Silence” selects no inbound volume during Standby mode. “All Listen” allows all Call Stations to be monitored during Standby mode.</p>
<pre>14:Selector Name S=xy: User Name</pre>	<p>Assignment of Station Selector names (Station Selector numbers 71 through 85 correspond to Station Selector ID numbers 1 through 15) where xy indicates Station Selector number. Default = SELECTOR xy where xy = Station Selector number (see “Keypad Function Definitions for Text Entry”).</p>
<pre>15:Station Name S=xy: User Name</pre>	<p>Assignment of Call Station names (01 through Max Stations) where xy indicates station number. Default = PUMP number xy where xy = station number (see “Keypad Function Definitions for Text Entry”).</p>

16:Music {On }
S=xy: User Name

A value (On, Off) for each Call Station. Default = On. Off will mute music at selected Call Station(s). This parameter is used to disable music at any Call Station. This parameter is used to disable music or messages at any Call Station.

17: All Call {On }
S=xy: User Name

A value (On, Off) for each Call Station. Default = On. Off will disable All Call broadcasts at selected Call Station(s). This parameter could be useful for disabling All Call broadcasts at a car wash or manager's office Call Station.

18:Registry {On }
S=xy: User Name

A value (On, Off) for each Call Station or Station Selector. Default = On. Off disables this Station Selector from connecting to specific Call Stations or Station Selectors. This could be useful for making specific Call Stations and Station Selectors inaccessible from this Station Selector, for privacy purposes. This Station Selector will still be able to receive calls from other Call Stations and Station Selectors.

19:Sync All Data
' T A L K ' = Yes

Command to synchronize all Station Selectors with the data from the Station Selector that issued the command. All data is synchronized with the exception of Selector ID #, Silence Calls, and Registry.

Are You Sure ?
' T A L K ' = Yes

This confirmation message follows the above. Station Selectors must be On Line to be synchronized.

20:Software Rev
Se=a.bc Con=x.yz

Read from Station Selector & Communications Controller. Station Selector and Communications Controller software revision numbers.

Keypad Function Definitions (for Text entry) (Programming State)

Key functions are defined below.

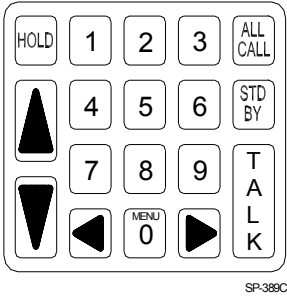

Figure 12. D-2400 Keypad

Key	Function												
HOLD (Shift)	Shifts between upper and lower case for text data.												
UP ARROW	Increments data by 1. Fields wrap around.												
DOWN ARROW	Decrements data by 1. Fields wrap around.												
1	Enters the digit 1 for numeric entry. Enters the following for text entry: <table border="1" style="margin-left: 40px;"> <tr> <td>Unshifted</td> <td>A</td> <td>B</td> <td>C</td> <td>1</td> <td>(</td> </tr> <tr> <td>Shifted</td> <td>a</td> <td>b</td> <td>c</td> <td>1</td> <td>)</td> </tr> </table>	Unshifted	A	B	C	1	(Shifted	a	b	c	1)
Unshifted	A	B	C	1	(
Shifted	a	b	c	1)								
2	Enters the digit 2 for numeric entry. Enters the following for text entry: <table border="1" style="margin-left: 40px;"> <tr> <td>Unshifted</td> <td>D</td> <td>E</td> <td>F</td> <td>2</td> <td>[</td> </tr> <tr> <td>Shifted</td> <td>d</td> <td>e</td> <td>f</td> <td>2</td> <td>]</td> </tr> </table>	Unshifted	D	E	F	2	[Shifted	d	e	f	2]
Unshifted	D	E	F	2	[
Shifted	d	e	f	2]								
3	Enters the digit 3 for numeric entry. Enters the following for text entry: <table border="1" style="margin-left: 40px;"> <tr> <td>Unshifted</td> <td>G</td> <td>H</td> <td>I</td> <td>3</td> <td>{</td> </tr> <tr> <td>Shifted</td> <td>g</td> <td>h</td> <td>i</td> <td>3</td> <td>}</td> </tr> </table>	Unshifted	G	H	I	3	{	Shifted	g	h	i	3	}
Unshifted	G	H	I	3	{								
Shifted	g	h	i	3	}								
4	Enters the digit 4 for numeric entry. Enters the following for text entry: <table border="1" style="margin-left: 40px;"> <tr> <td>Unshifted</td> <td>J</td> <td>K</td> <td>L</td> <td>4</td> <td>←</td> </tr> <tr> <td>Shifted</td> <td>j</td> <td>k</td> <td>l</td> <td>4</td> <td>→</td> </tr> </table>	Unshifted	J	K	L	4	←	Shifted	j	k	l	4	→
Unshifted	J	K	L	4	←								
Shifted	j	k	l	4	→								
5	Enters the digit 5 for numeric entry. Enters the following for text entry: <table border="1" style="margin-left: 40px;"> <tr> <td>Unshifted</td> <td>M</td> <td>N</td> <td>O</td> <td>5</td> <td>:</td> </tr> <tr> <td>Shifted</td> <td>m</td> <td>n</td> <td>o</td> <td>5</td> <td>;</td> </tr> </table>	Unshifted	M	N	O	5	:	Shifted	m	n	o	5	;
Unshifted	M	N	O	5	:								
Shifted	m	n	o	5	;								

Key	Function												
6	<p>Enters the digit 6 for numeric entry. Enters the following for text entry:</p> <table border="1" style="margin-left: auto; margin-right: auto;"> <tr> <td>Unshifted</td> <td>P</td> <td>Q</td> <td>R</td> <td>6</td> <td></td> </tr> <tr> <td>Shifted</td> <td>p</td> <td>q</td> <td>r</td> <td>6</td> <td> </td> </tr> </table>	Unshifted	P	Q	R	6		Shifted	p	q	r	6	
Unshifted	P	Q	R	6									
Shifted	p	q	r	6									
7	<p>Enters the digit 7 for numeric entry. Enters the following for text entry:</p> <table border="1" style="margin-left: auto; margin-right: auto;"> <tr> <td>Unshifted</td> <td>S</td> <td>T</td> <td>U</td> <td>7</td> <td>.</td> </tr> <tr> <td>Shifted</td> <td>s</td> <td>t</td> <td>u</td> <td>7</td> <td>!</td> </tr> </table>	Unshifted	S	T	U	7	.	Shifted	s	t	u	7	!
Unshifted	S	T	U	7	.								
Shifted	s	t	u	7	!								
8	<p>Enters the digit 8 for numeric entry. Enters the following for text entry:</p> <table border="1" style="margin-left: auto; margin-right: auto;"> <tr> <td>Unshifted</td> <td>V</td> <td>W</td> <td>X</td> <td>8</td> <td>&</td> </tr> <tr> <td>Shifted</td> <td>v</td> <td>w</td> <td>x</td> <td>8</td> <td>@</td> </tr> </table>	Unshifted	V	W	X	8	&	Shifted	v	w	x	8	@
Unshifted	V	W	X	8	&								
Shifted	v	w	x	8	@								
9	<p>Enters the digit 9 for numeric entry. Enters the following for text entry:</p> <table border="1" style="margin-left: auto; margin-right: auto;"> <tr> <td>Unshifted</td> <td>Y</td> <td>Z</td> <td>#</td> <td>9</td> <td>'</td> </tr> <tr> <td>Shifted</td> <td>y</td> <td>z</td> <td>,</td> <td>9</td> <td>"</td> </tr> </table>	Unshifted	Y	Z	#	9	'	Shifted	y	z	,	9	"
Unshifted	Y	Z	#	9	'								
Shifted	y	z	,	9	"								
0/MENU	<p>Enters the digit 0 for numeric entry. Enters the following for text entry:</p> <table border="1" style="margin-left: auto; margin-right: auto;"> <tr> <td>Unshifted</td> <td>+</td> <td>*</td> <td>=</td> <td>0</td> <td><</td> </tr> <tr> <td>Shifted</td> <td>-</td> <td>/</td> <td>^</td> <td>0</td> <td>></td> </tr> </table>	Unshifted	+	*	=	0	<	Shifted	-	/	^	0	>
Unshifted	+	*	=	0	<								
Shifted	-	/	^	0	>								
LEFT ARROW	Jump left to next data field.												
RIGHT ARROW	Jump right to next data field.												
ALL CALL	Exits the programming state and enters Off Line mode.												
STD BY	Clear the data field to its default value (space for text or the default value).												
TALK	Enter key where appropriate.												

Adjusting the System

Inbound Audio Volume Level

To set the inbound audio volume level:

1. Ask an attendant to stand at a Call Station and push the incoming call button for your Station Selector.
2. Answer the call by pressing the TALK button.
3. As the attendant talks, adjust the up/down arrows on the Station Selector keypad to reach a desirable level.

VOX (Voice Operated Transmission) Sensitivity Level

 Important
The VOX adjustments are necessary only if VOX is enabled for your system.

The VOX sensitivity level determines the maximum distance from the microphone that the speaker can activate communication.

 Important
The suggested average activation distance from the microphone to the attendant is 2 to 6 inches.

To set the VOX sensitivity level:

1. Follow the directions under the section *Programming the System* to put the Station Selector in programming mode.
2. Locate the VOX Enable parameter and be sure it is set to ON.
3. Locate the VOX Sensitive parameter and press the right-arrow key to edit the value.
4. Use the up/down arrow keys to adjust sensitivity:
 - The up arrow key increases the sensitivity (lengthens the distance from the microphone to the attendant). Fifteen is most sensitive.
 - The down arrow key decreases sensitivity. One is least sensitive.
5. Press the ALL CALL key to exit Programming

Outbound Talk Volume Level

To set the outbound Talk volume level:

1. Follow the directions under the section *Programming the System* to put the Station Selector in programming mode
2. Locate the Talk Vol parameter and follow instructions in that section.

Outbound Music/Messaging Volume Level (Only for systems that use Music/Messaging)

To set the outbound Music/Messaging volume level:

1. Follow the directions under the section *Programming the System* to put the Station Selector in programming mode
2. Locate the Music Volume parameter and follow the instructions in that section.

Testing the Functions

Perform the following tests after installing the Performance Series D-2400 Intercom System:

1. Checking TALK/LISTEN switching.
 - a. Ask an attendant to go to Call Station 1 and press the call button.
 - b. Establish a connection with the CALL STATION (press TALK on the Station Selector or Remote Microphone).
 - c. Talk and listen to the attendant to determine that the TALK and LISTEN modes are functioning satisfactorily.
 - d. Repeat Steps a through c for all CALL STATIONS.
2. Checking ALL CALL.
 - a. Ask an attendant to go to a Call Station.
 - b. Activate ALL CALL (press and hold ALL CALL on the Station Selector or Remote Microphone).
 - c. Broadcast an announcement from the Station Selector.
 - d. Ask the attendant to verify that the message is broadcast from all Call Stations, which have not been disabled.

Configuration Worksheets

**CONFIGURATION WORKSHEET 1
COMMUNICATIONS CONTROLLER-CALL STATION CONNECTIONS**

4 STATION COMMUNICATIONS CONTROLLER

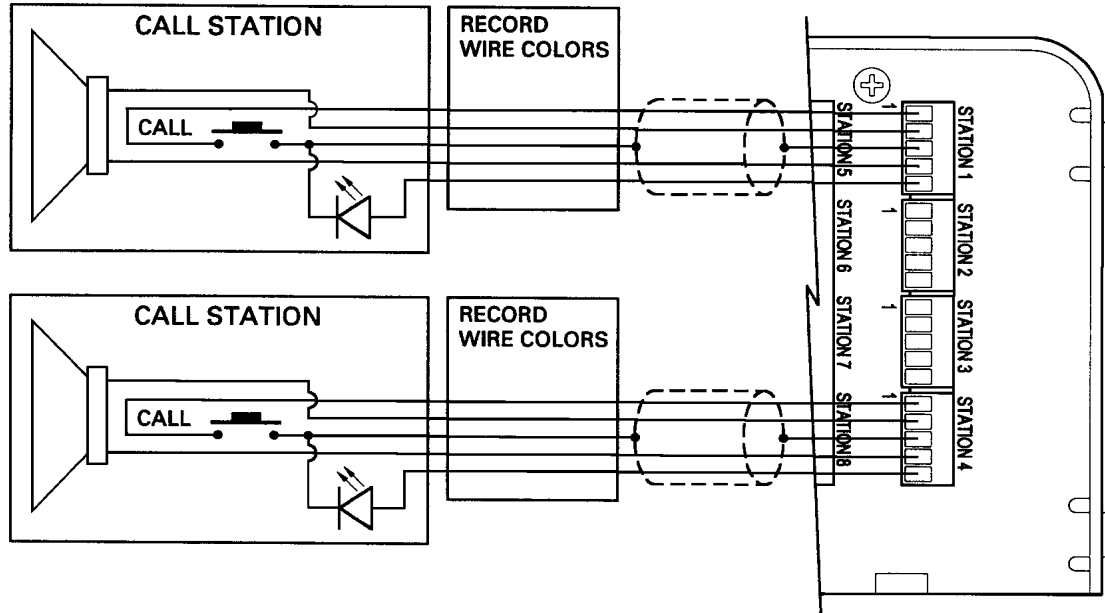

**IMPORTANT:
RECORD WIRE COLORS.
STORE THIS DOCUMENT IN THE
COMMUNICATIONS CONTROLLER.**

**COMMUNICATIONS CONTROLLER
SPEAKER CONNECTION PIN-OUT**

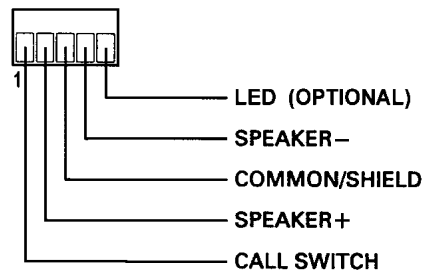

24 STATION COMMUNICATIONS CONTROLLER

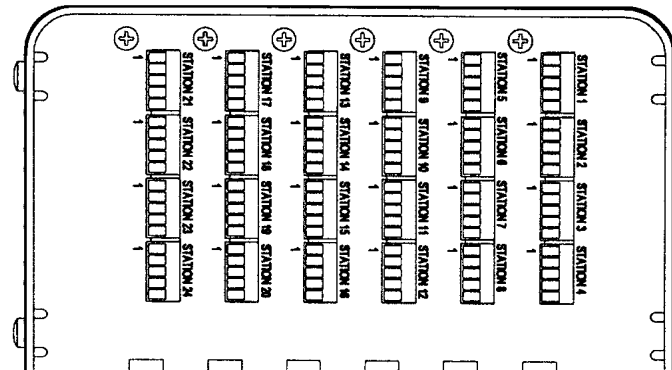

CONFIGURATION WORKSHEET 2 COMMUNICATIONS CONTROLLER-STATION SELECTOR AUDIO CONNECTIONS

IMPORTANT
RECORD WIRE COLORS.
STORE THIS DOCUMENT IN THE
COMMUNICATIONS CONTROLLER.

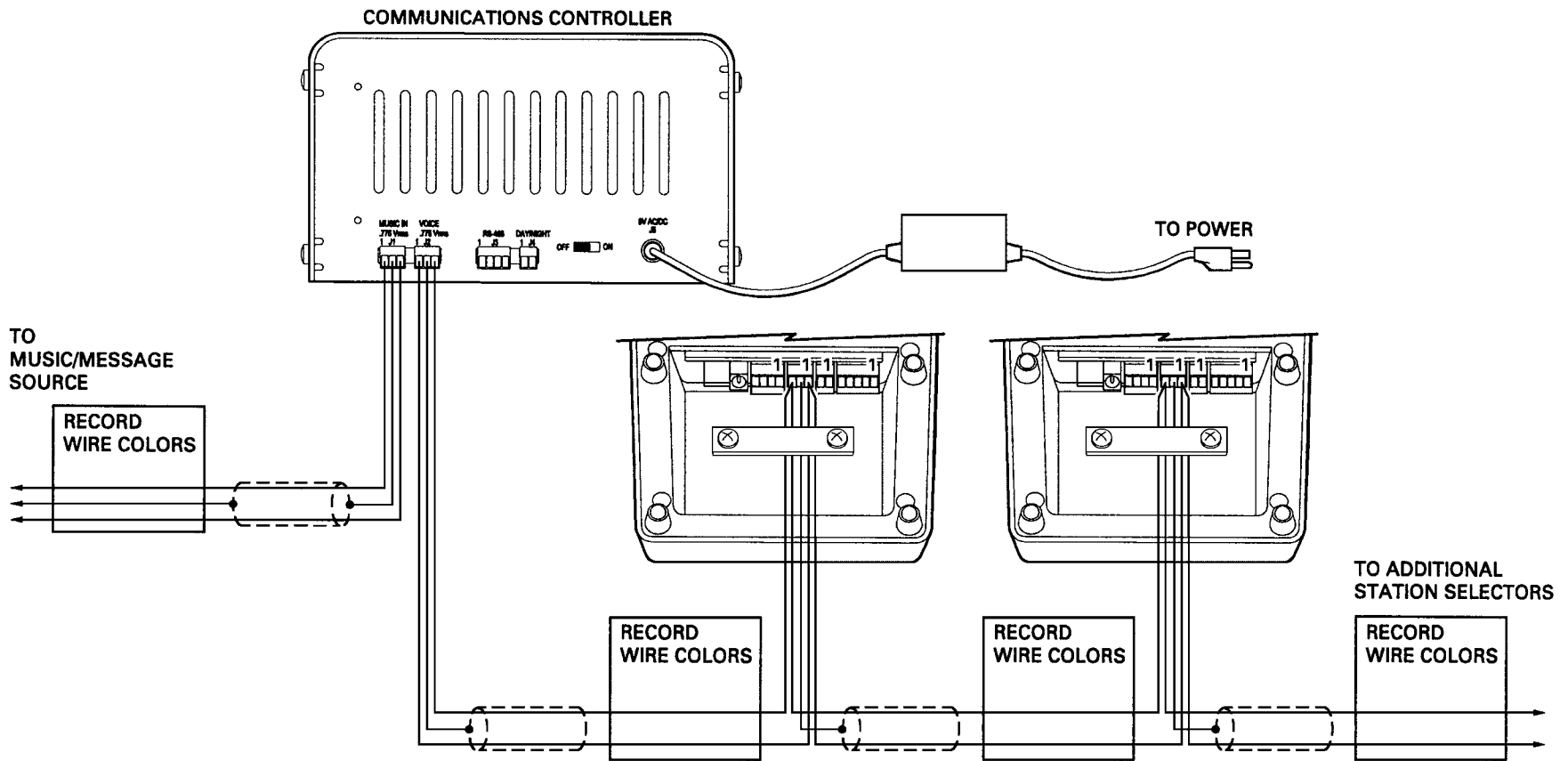

CONFIGURATION WORKSHEET 3 COMMUNICATIONS CONTROLLER-STATION SELECTOR RS-485 and OTHER CONNECTIONS

IMPORTANT:
RECORD SETTINGS AND WIRE COLORS.
STORE THIS DOCUMENT IN THE
COMMUNICATIONS CONTROLLER.

NOTE:
DAY/NIGHT SWITCH SET TO
NIGHT POSITION REDUCES
OUTBOUND VOLUME 10 DB.

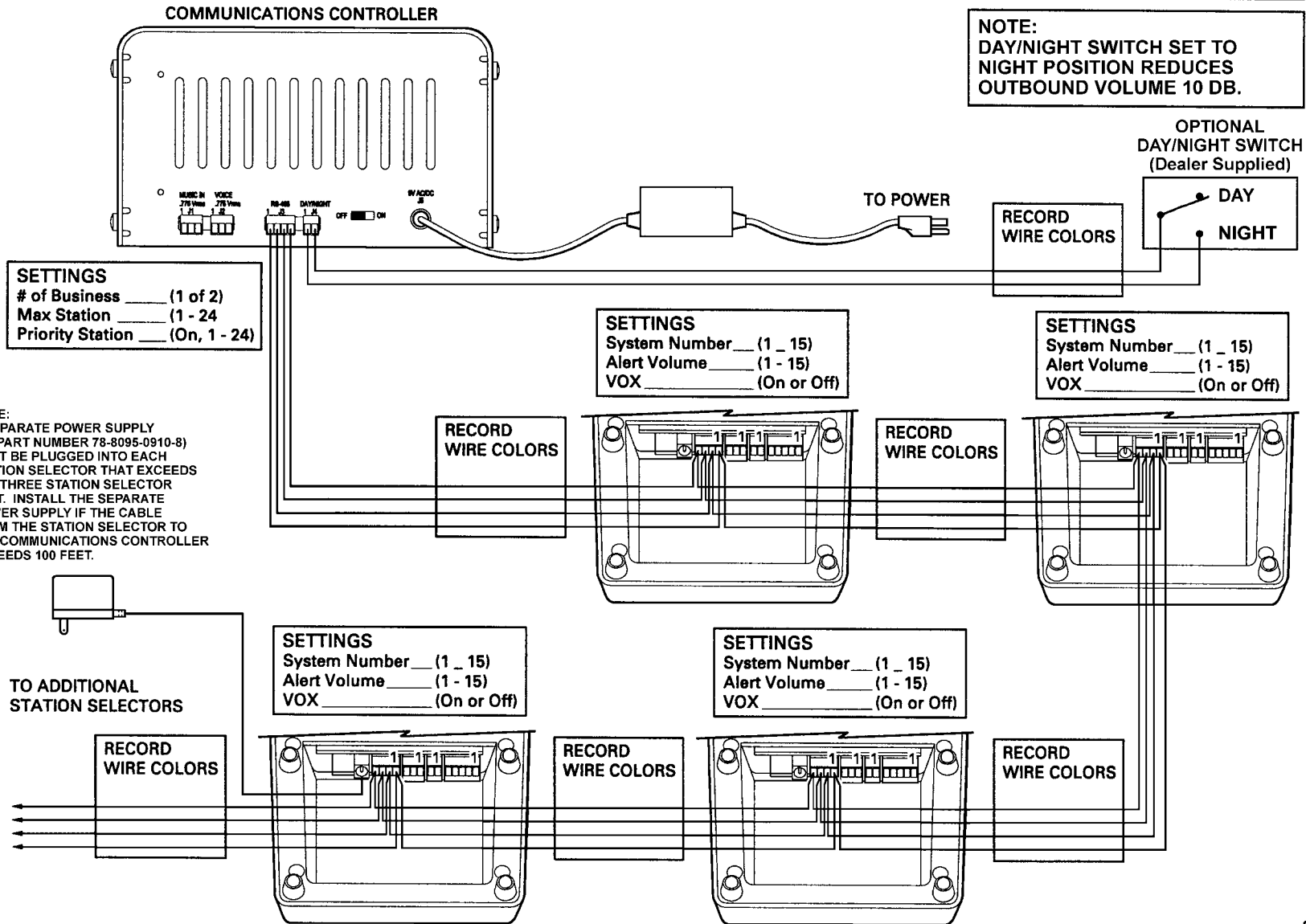

NOTE:
A SEPARATE POWER SUPPLY
(3M PART NUMBER 78-8095-0910-8)
MUST BE PLUGGED INTO EACH
STATION SELECTOR THAT EXCEEDS
THE THREE STATION SELECTOR
LIMIT. INSTALL THE SEPARATE
POWER SUPPLY IF THE CABLE
FROM THE STATION SELECTOR TO
THE COMMUNICATIONS CONTROLLER
EXCEEDS 100 FEET.



Commercial Care Division

Food Service Business

3M Center

St. Paul, MN 55144-1000

Printed in U.S.A.

© 3M 2004 April

78-6912-0739-9 Rev B